

Construction

Close-coupled self-priming centrifugal pumps with built-in strainer.

NMP: version with pump casing and lantern bracket in cast iron.
 B-NMP: version with pump casing and lantern bracket in bronze (the pumps are supplied fully painted).

Applications

For water circulation in swimming pool filtration systems.
 For clean or slightly dirty water with solids in suspension.

Operating conditions

Liquid temperature up to 60° C.
 Ambient temperature up to 40° C.
 Total suction lift up to 7 m.
 Maximum permissible working pressure up to 6 bar.
 Continuous duty.

Motor

2-pole induction motor, 50 Hz (n = 2900 rpm).

NMP: three-phase 230/400 V ± 10% up to 3 kW;
 400/690 V ± 10% from 4 to 11 kW;

NMPM: single-phase 230 V ± 10%, with thermal protector.

Insulation class F.

Protection IP 54.

Constructed in accordance with: EN 60034-1;
 EN 60335-1, EN 60335-2-41.

Materials

Components	NMP	B-NMP
Pump casing	Cast iron	Bronze
Lantern bracket	GJL 200 EN 1561	G-Cu Sn 10 EN 1982
Impeller	Cast iron	Bronze
	GJL 200 EN 1561	G-Cu Sn 10 EN 1982
	Brass P- Cu Zn 40 Pb 2 UNI 5705 for NMP 32/12	
Shaft	Chrome-nickel steel	Cr-Ni-Mo steel
	1.4305 EN 10088 (AISI 303)	1.4401 EN 10088 (AISI 316)
Strainer cover	Cast iron	Bronze
	GJL 200 EN 1561	G-Cu Sn 10 EN 1982
Strainer	Chrome-nickel steel 1.4301 EN 10088 (AISI 304)	
Mechanical seal	Carbon - Ceramic - FPM	

Special features on request

- Other voltages.
- Frequency 60 Hz (as per 60 Hz data sheet).
- Protection IP 55.
- Special mechanical seal
- Higher liquid or ambient temperatures.

Coverage chart n ≈ 2900 rpm

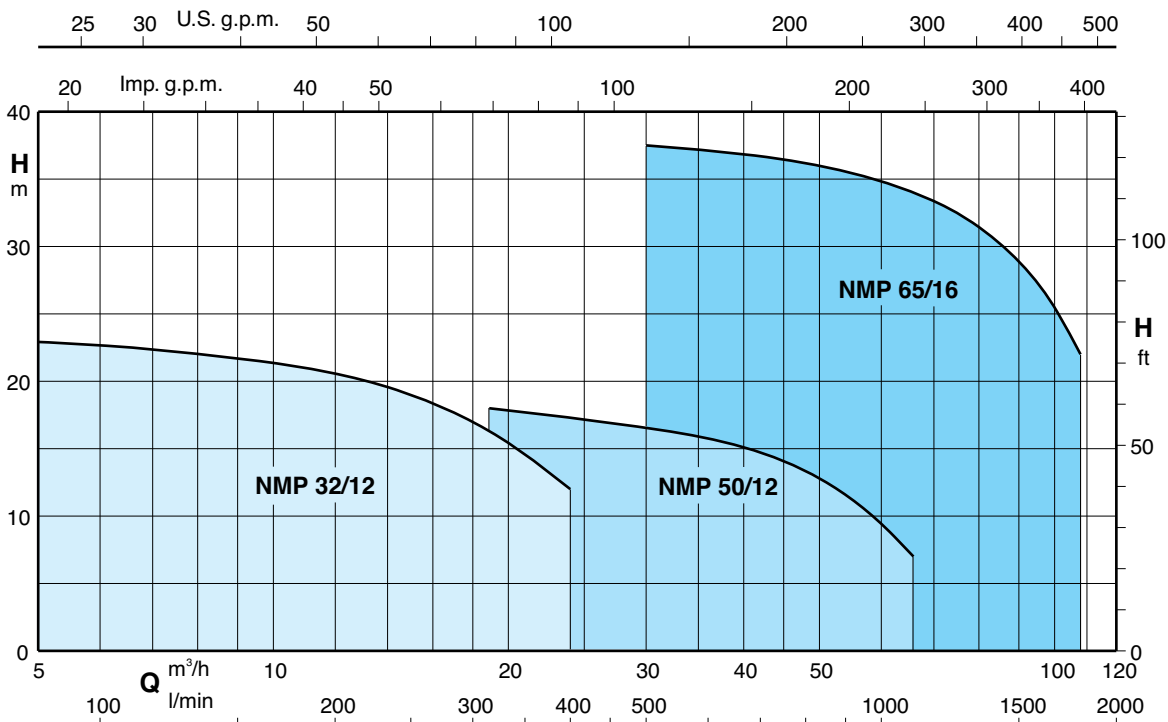

Performance n ≈ 2900 rpm

3 ~			1 ~			P ₁			P ₂			Q																												
230V		400V	230V		P ₁	P ₂		m³/h	l/min	6,6	9,6	10,8	12	13,2	15	18,9	21	24	30	42	48	54	60	66	75	84	96	108												
A	A	A	kW	kW	HP	110	160			180	200	220	250	315	350	400	500	700	800	900	1000	1100	1250	1400	1600	1800														
B-NMP 32/12FE	4	2,3	B-NMPM 32/12FE			4,5	0,8	0,55	0,75	13	12	11	10,5	10	9																									
B-NMP 32/12DE	4	2,3	B-NMPM 32/12DE			5,8	1,3	0,75	1	12	11	10	9,5	9	8																									
B-NMP 32/12AE	5	2,9	B-NMPM 32/12AE			7,4	1,85	1,1	1,5	18	17	16	15,5	15	14																									
B-NMP 32/12SE	7,5	4,3	B-NMPM 32/12SE			9,2	2	1,5	2	17	16	15	14,5	14	13																									
B-NMP 50/12HE	5	2,9	B-NMPM 50/12HE			7,4	1,85	1,1	1,5	22	21	20,5	20	19,5	18,5																									
B-NMP 50/12GE	7,5	4,3	B-NMPM 50/12GE			9,2	2	1,5	2	21,5	20,5	19,5	19	18,5	17,5																									
B-NMP 50/12FE	9,15	5,3						2,2	3	22,5	21,5	21	20,5	20	19	16*	15*	12*																						
B-NMP 50/12DE	11,5	6,6						3	4							9	9	8,5	7,5	5,5	4,5	3																		
B-NMP 65/16FE		9,6						4	5,5							12	12	11,5	10,5	8	7	5	3,5*																	
B-NMP 65/16EE		12						5,5	7,5							16	16	15,5	14,5	12	10,5	8,5	6,5*	5*																
B-NMP 65/16DE		16						7,5	10							18	18	17,5	16,5	15	13	11,5	9,5*	7*																
B-NMP 65/16CE		18,5						9,2	12,5										18	17	16,5	15,5	14,5	13,5	11,5	9,5	6,5*													
B-NMP 65/16AE		21,5						11	15											20,5	19,5	19	18	17	16	14,5	12,5	9,5*												

P₁: Maximum power input. B-NMP = Bronze construction. * Maximum suction lift 2-3 m.
P₂: Rated motor power output. H Total head in m. Tolerances according to ISO 9906, annex A.

Dimensions and weights

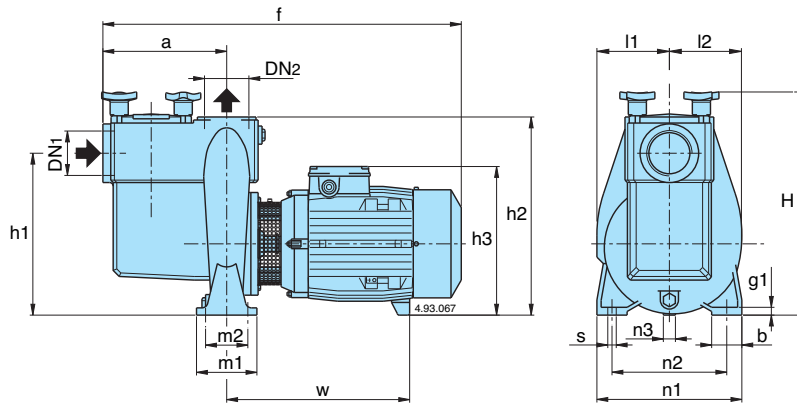

TYPE	DN ₁	DN ₂	mm																	
			ISO 228	a	f	h ₁	h ₂	h ₃	H	m ₁	m ₂	n ₁	n ₂	n ₃	b	s	l	l ₁	l ₂	w
B-NMP 32/12AE-DE-FE B-NMP 32/12SE	G 2	G 2	195	510	230	280	228	320	100	70	190	140	30	50	14	-	106	99	220	12
B-NMP 50/12FE-GE-HE B-NMP 50/12DE	G 2 ^{1/2}	G 2 ^{1/2}	205	540 602	262	322	240	360	100	70	240	190	37 20	50	14	-	120	117	234 298	12
B-NMP 65/16FE B-NMP 65/16DE-EE B-NMP 65/16AE-CE	G 3	G 3	320	717 748 858	360	440	320 470	125	95	280	212	49 60 43	65	14	-	165	164	319 319	15	

TYPE	NMP kg	B-NMP kg
B-NMP 32/12FE	30	32
B-NMP 32/12DE	30	32
B-NMP 32/12AE	31	33
B-NMP 32/12SE	33	35
B-NMP 50/12HE	37	39
B-NMP 50/12GE	38,5	40
B-NMP 50/12FE	38,5	41,5
B-NMP 50/12DE	47,5	51,5
B-NMP 65/16FE	78,5	89
B-NMP 65/16EE	91	101
B-NMP 65/16DE	97	107
B-NMP 65/16CE	121	130
B-NMP 65/16AE	127	137

Characteristic curves $n \approx 2900$ rpm

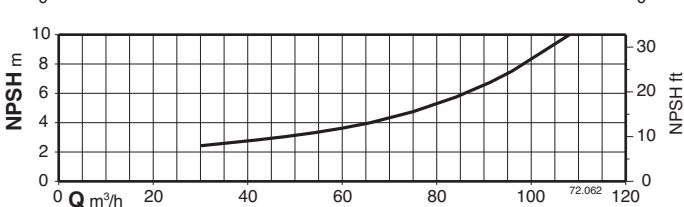
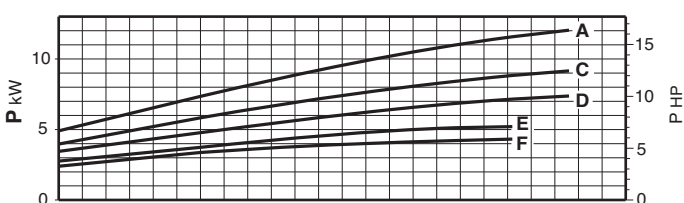
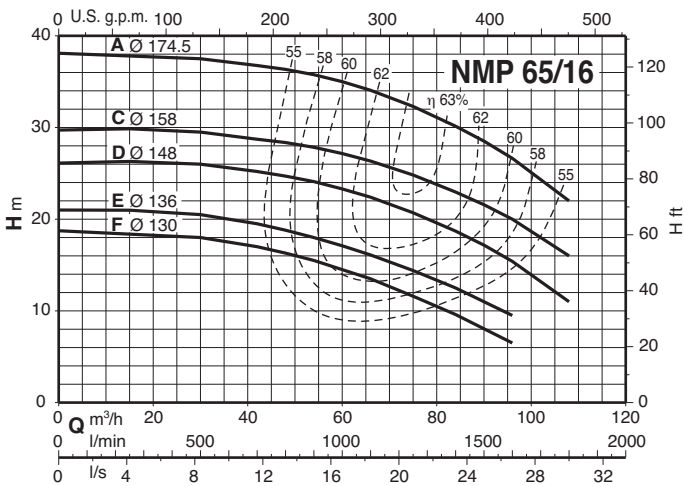
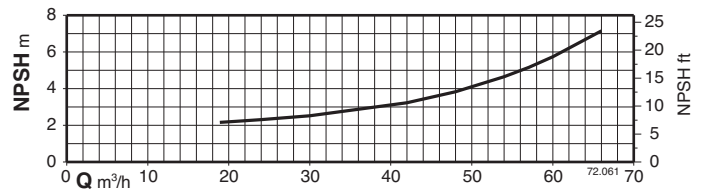
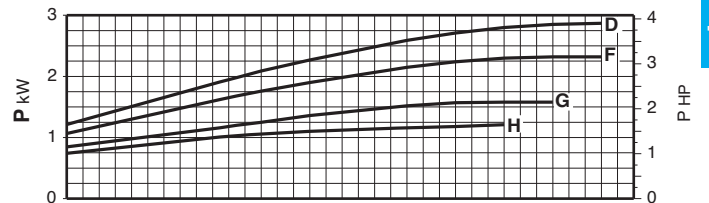
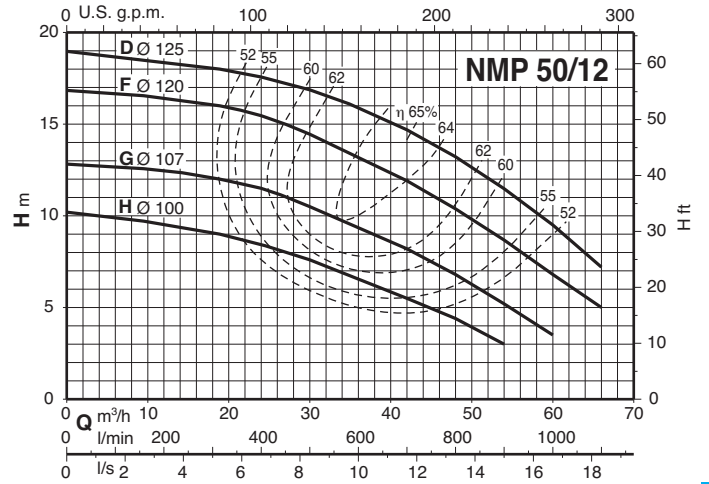
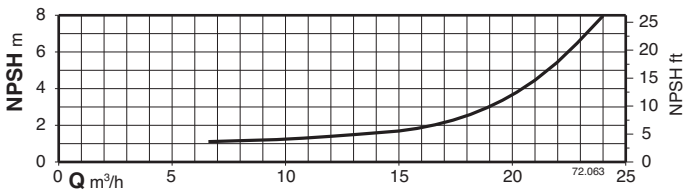
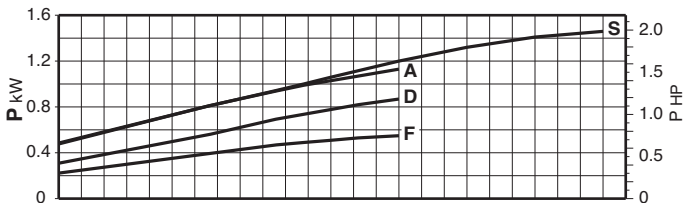
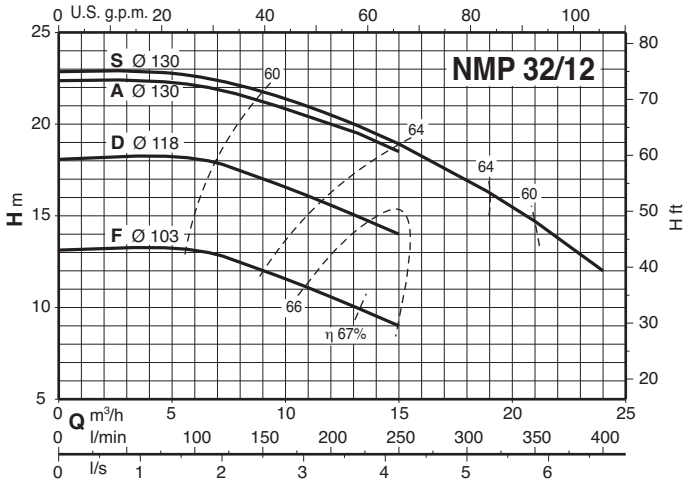

15